

Asuinkerrostalo Kempeleen
Vihiluotoon
Nea Hämäläinen



yhteisprojekti YS
NARK
RO



VIHILUOTO VIITESUUNNITELMA

yhteisprojekti **YS**
NARK
RO

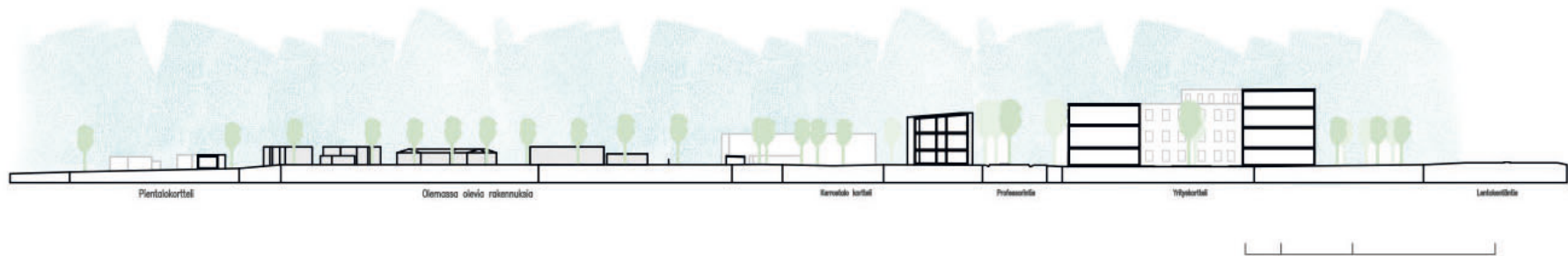
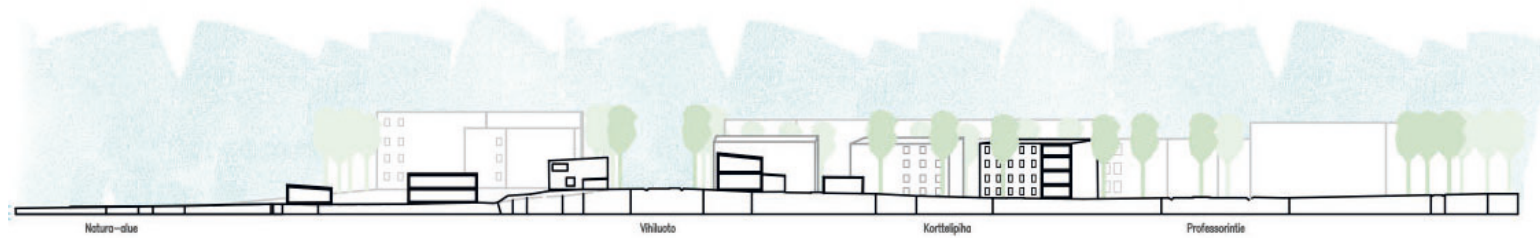

VIHILUOTO ALUELEIKKAUKSET





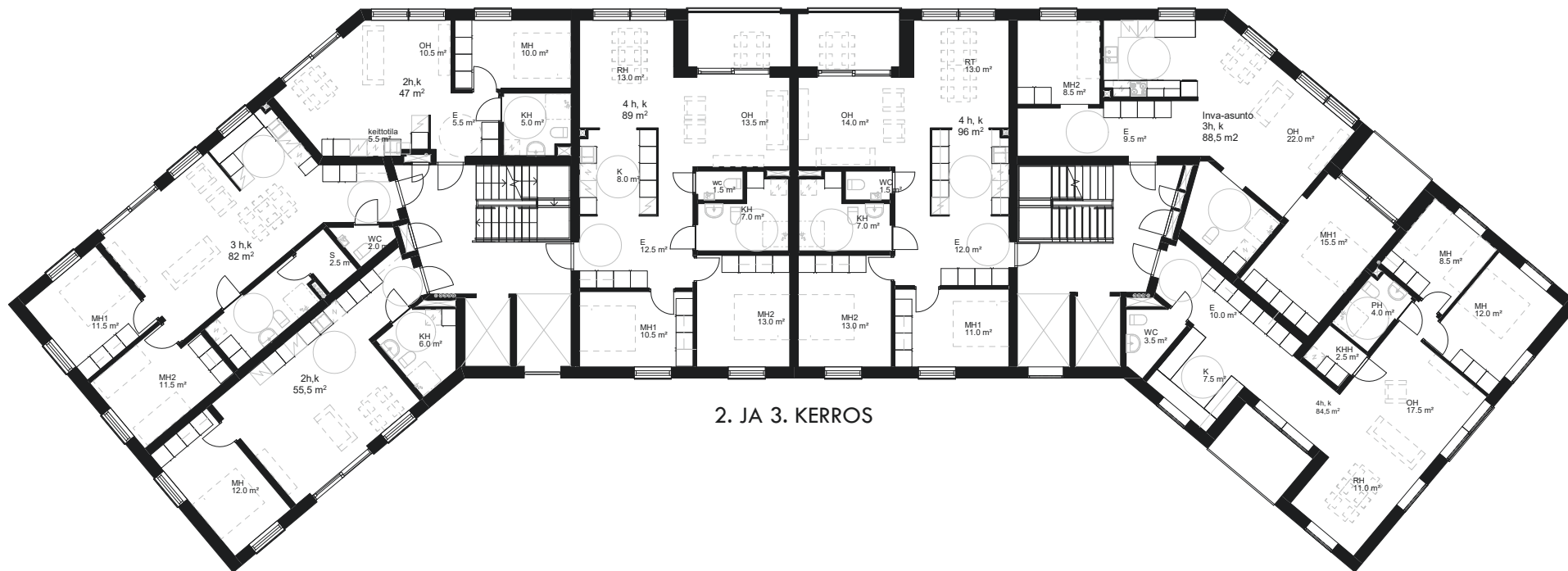

2. JA 3. KERROS



4.KERROS



ITÄÄN

POHJOISEEN

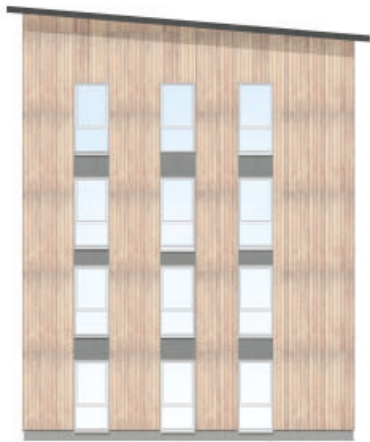

LÄNTEEN



ETELÄÄN

JULKISIVUMATERIAALIT: 1. PUUPANEELI KUULTOKÄSITELTY 2. KUITUSEMSENTTILEVY TUMMANHARMAA 3. SOKKELILEVY TUMMANHARMAA 4. HUOPAKATE TUMMANHARMAA 5. KUUMASINKITTY TERÄS TUMMANHARMAA

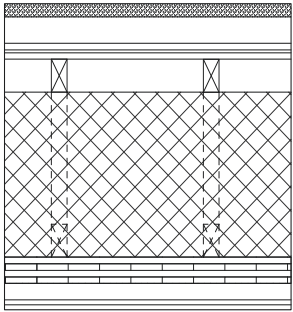

YP3 kattoterassi

40 mm	Betonilaatat
80 mm	Asennushiekka
	Suodatinkangas
19 mm	Vaneri pontattu
650 mm	Kattoristikko K600
150 mm	Tuuletusväli
500 mm	Mineraalivilla
80 mm	CLT-levy, 5 kerroksinen
50 mm	Puukoolaus 50x50 mm
15 mm	Kipsilevy
15 mm	Kipsilevy

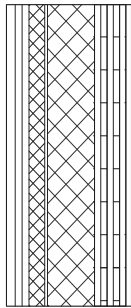

US1 ei kantava ulkoseinä

28 mm	Pystypaneeli UYS 28x120 mm, kuultokäsitelty
22 mm	Puukoolaus 22x100mm K600
22 mm	Puukoolaus 22x100mm K600
	Palokatkot 1 kpl/kerros
50 mm	Tuulensuojamineraalivilla
	Puukoolaus 50x50 mm K600
150 mm	Uumapalkit K600
	Mineraalivilla
100 mm	CLT-levy 5 kerroksinen
18 mm	Kuitukipsilevy
	Maalaus

VP1 Väliohjauskuiva-tila

8 mm	Laminaatti
2 mm	Laminaatinalusmatto
60 mm	Betonivalu
30 mm	Askeläänimatto
80 mm	CLT-levy, 5 kerroksinen
	Vaimennuskaistat palkkien päälle
400 mm	Liimapuupalkki K600
100 mm	Mineraalivilla
50 mm	Puukoolaus 50x50 mm K600
	Sprinklerijärjestelmä
25 mm	Akustinen jousiranka
15 mm	Kipsilevy
15 mm	Kipsilevy
	Maalaus

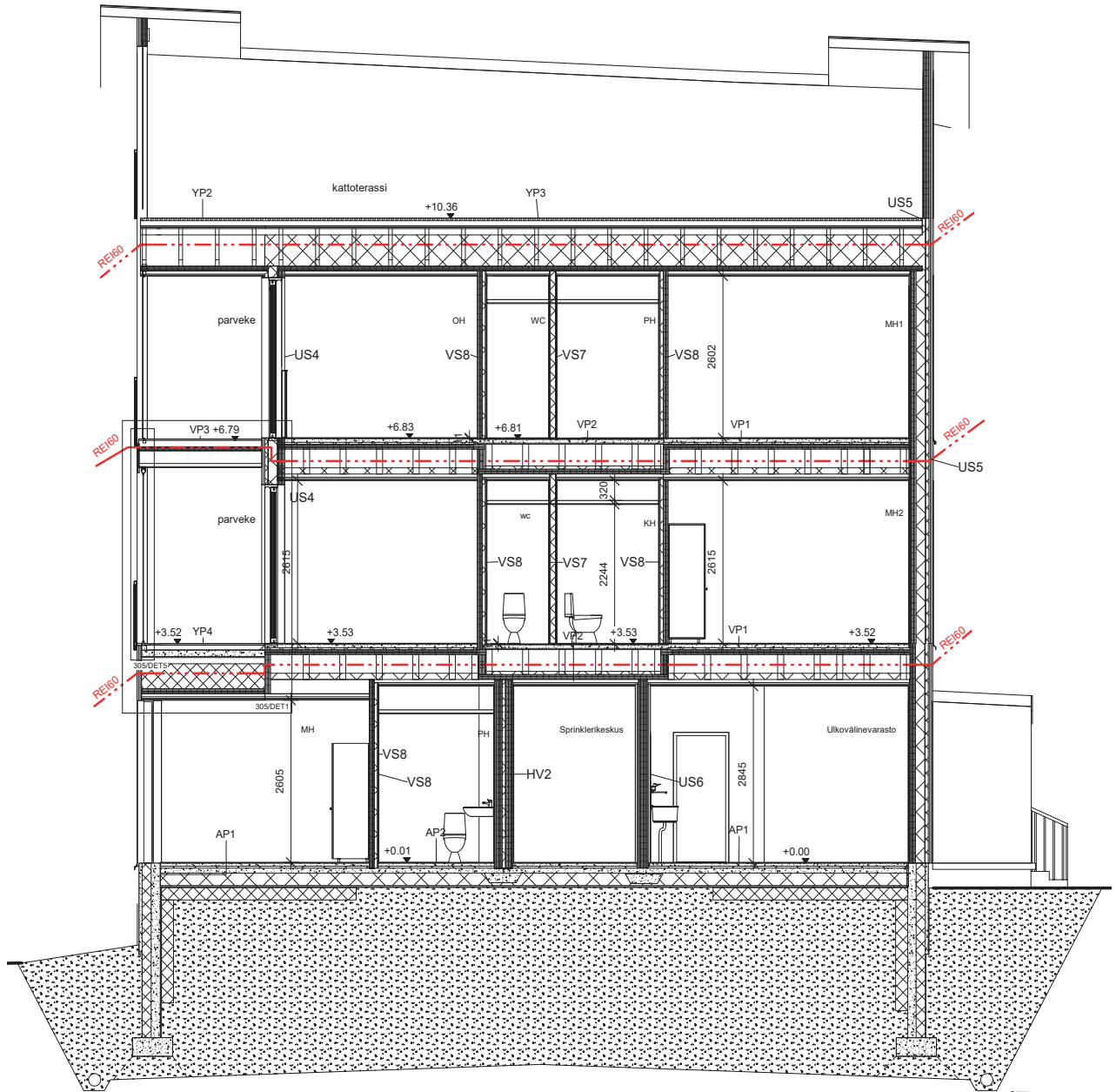
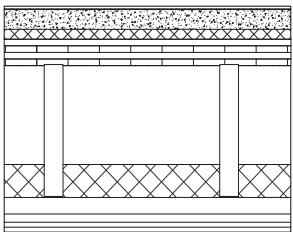

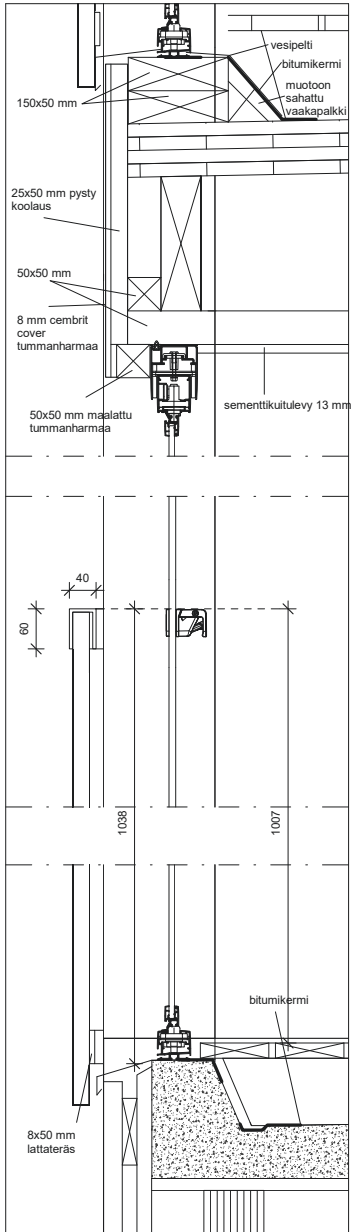

DET5 PARVEEKEN ETUOSA

PARVEKEPIIRROKSET

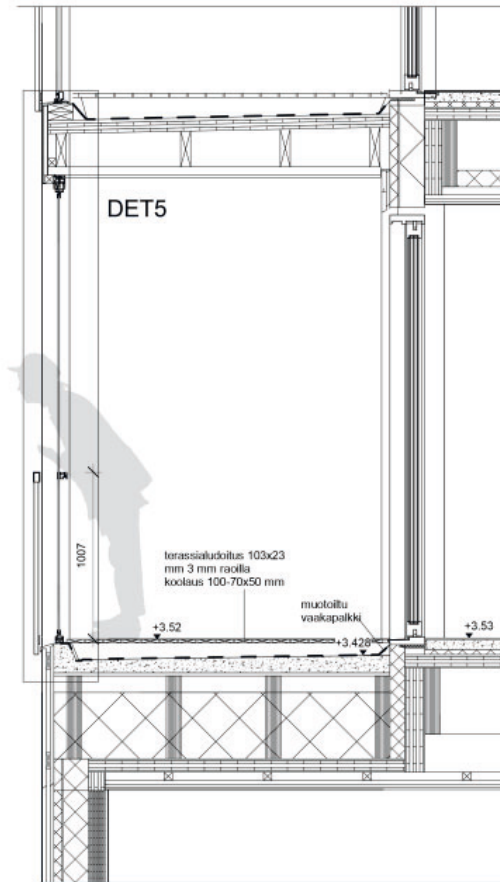

DET1 PARVEKE LEIKKAUS

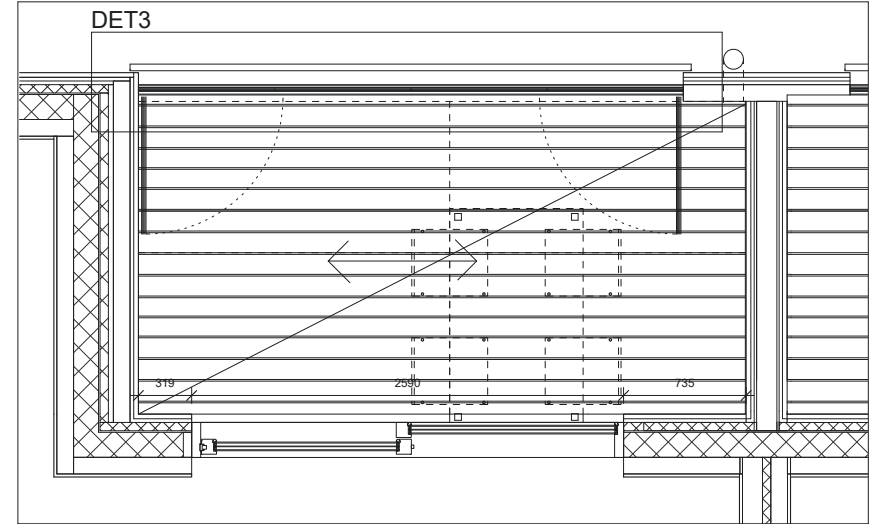

DET2 PARVEKE POHJAPIIRROS

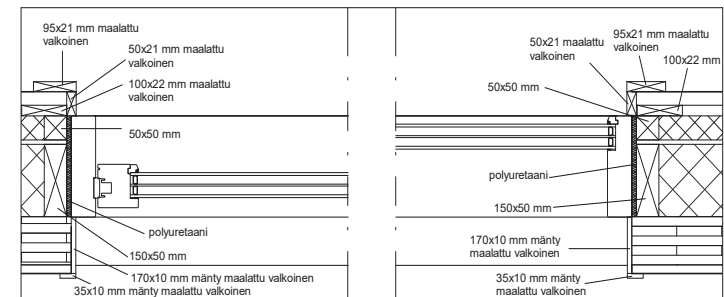

LIUKUOVEN VAAKALEIKKAUS

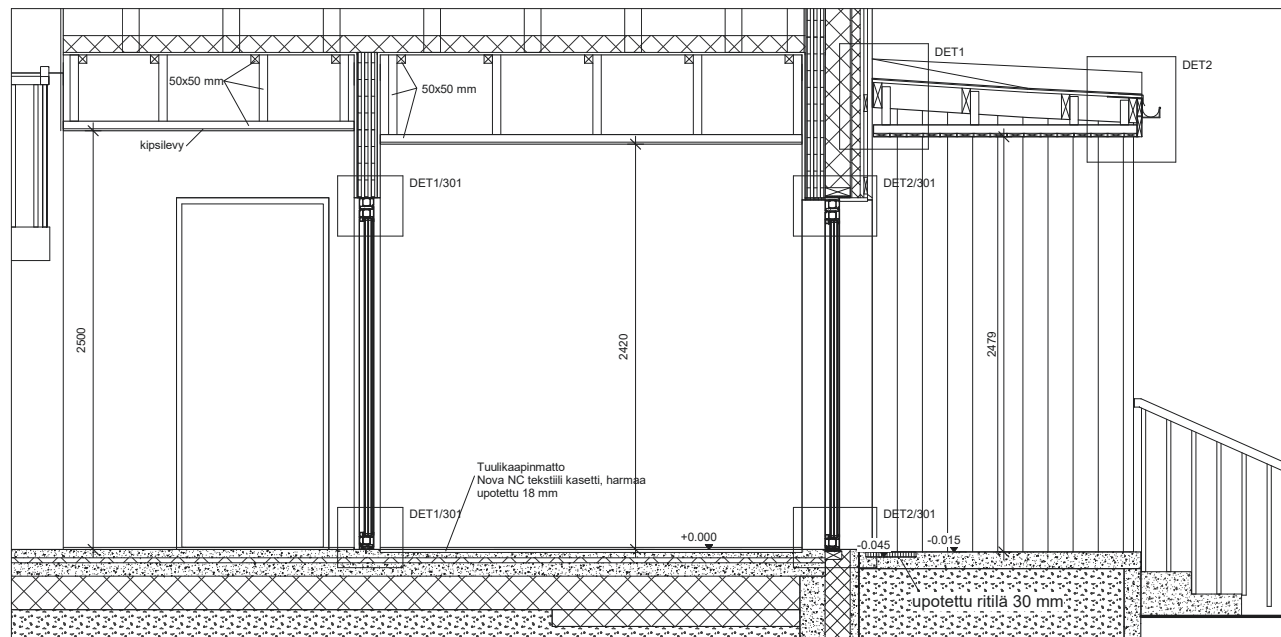

SISÄÄNKÄYNTIJÄRJESTELYT



yhteisprojekti
YS
NARK
RO